

# W LED

Project Name:	
Type:	



### APPLICATION

Specification grade surface ceiling-mount standard wraparound fixture delivers diffuse moderate light. It is the economical, energy-efficient, high performance and low-profile choice for small to medium size offices, retail spaces, classrooms and storage rooms.

### FEATURES:

- 0.08" thk 100% acrylic, injection molded prismatic basket diffuser with flat bottom and vertical sides.
- Die formed, cold-rolled, heavy gauge steel housing construction provides durability and strength.
- End caps are same material as housing.
- Lens are capable of being hinged from either side for easy cleaning and service.
- Available with in narrow and wide housing.
- Finish is high-gloss baked white enamel over rust inhibiting phosphate coating for maximum corrosion resistance.
- Paint after fabrication.

### MOUNTING:

- Surface mount.
- Stem mount (1/2" std, 3/8" optional) (pipe by others unless ordered).
- Steel end plates with 7/8" KO standard for continuous row mounting option.
- Compatible with most ceiling types.

### LED:

- High quality array LEDs.
- LM80
- Color Temperature: 2700/3000/3500/4000/5000 (K)
- Color Rendering Index: > 82.8
- Calculated L70: 122,000 hours
- Reported L70: +60,000 hours

### ELECTRICAL:

- High power factor electronic driver, operate from a 120 ~ 277 Vac input range, 50 / 60 Hz.
- Features included over voltage protection, surge, short circuit protection and over load protection.
- Power Factor: typical > 0.95, THD <20, meets Class1 or Class 2 circuit.
- Philips Xitanium: 0-10V Dim to 1%(PH).
- Osram Optotronic: 0-10V Dim to 1%(OS1) or 10%(OS).
- Generic : 0-10V 10% dim. (GR)
- Operating temperature: -4°F (-20°C) ~ 122°F (50°C).

### <ELCU-200>

- Guarantees emergency lighting remains ON or is turned on when power to the control device is lost.
- Interfaces with fire alarm panel or security system.
- "Watchdog" feature allows emergency loads to be controlled in tandem with normal power loads.
- UL listed for use in emergency circuits.

### LISTING:

- UL/CUL listed.
- Listed to UL 1598 and UL 8750.
- DLC listed. <sup>3</sup>
- Suitable for damp locations.
- CEC Compliant EM (please contact for more information)
- Optional ARRA compliant.
- 5 years limited warranty.
- 7 or 10 years limited warranty. (optional) <sup>4</sup>
- Bluetooth Mesh System available, please contact factory for more information.

### CONFIGURATIONS

Series	Size	LED Watts	AC Input	Lumen Output	Driver Input
W	2FT	18LED	19.8W	2126.52 lm	277V
		25LED	27.5W	2953.5 lm	
		36LED	39.6W	4253.04 lm	
	4FT	18LED	19.8W	2126.52 lm	
		25LED	27.5W	2953.5 lm	
		36LED	39.6W	4253.04 lm	
		54LED	59.4W	6379.56 lm	
		72LED	79.2W	8506.08 lm	
		54LED	59.4W	6379.56 lm	
	8FT	72LED	79.2W	8506.08 lm	
		108LED	118.8W	12759.12 lm	

: Based on 3500K.

### OUTPUT CURRENT

		Bi-Level		Tri-Level (Default)	
SW1	SW2	Config Range	Default	Config Range	Default
Close	Open	10% - 70%	40%	10% - 70%	30%
Open	Close	10% - 70%	40%	10% - 70%	70%
Close	Close	100%	100%	100%	100%
Open	Open	0%	0%	0%	0%

### MULTIPLIER CHART

	Multiplier		
CCT	3000K	4000K	5000K
2FT	0.958	1.0112	1.0214
4FT	0.988	1.0122	1.0245
8FT	0.989	1.0122	1.0235

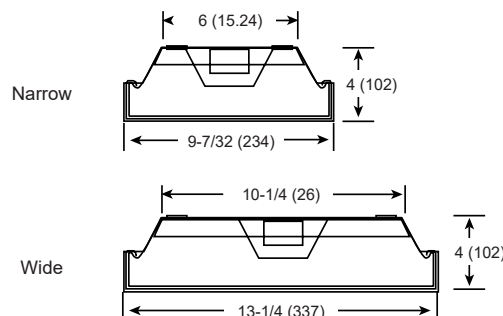

#### Specifications: W-2

Weight: 7.56 lbs (3.43 kg)

#### Specifications: W-4

Weight: 11.97 lbs (5.43 kg)

#### Specifications: W-8

Weight: 19.69 lbs (8.93 kg)

ORDERING INFORMATION

EXAMPLE: W-4-2G-36LED-40K-UNV-SD50

MODEL	LENGTH	GENERATION	WIDTH	LED	COLOR TEMP.	EFFICACY
<b>W</b>	<b>2</b> 2' Length <b>4</b> 4' Length <b>8</b> 8' Length <sup>11</sup>	<b>2G</b> 2ND Generation	<b>(Blank)</b> Narrow (Std.) <b>W</b> Wide <sup>1</sup>	<b>18LED</b> 18W LED <b>25LED</b> 25W LED <sup>6</sup> <b>36LED</b> 36W LED <b>54LED</b> 54W LED <b>72LED</b> 72W LED <b>108LED</b> 108W LED  <small>* Contact factory for custom wattage or lumen requirement.</small>	<b>-27K</b> 2700K <sup>7</sup> <b>-30K</b> 3000K <b>-35K</b> 3500K <b>-40K</b> 4000K (Std.) <b>-50K</b> 5000K	<b>(Blank)</b> Standard <b>HE</b> High Efficacy 

CRI	DIFFUSER	VOLTAGE	LED DRIVER
<b>(Blank)</b> 80+ CRI <b>C9</b> 90+ CRI <sup>8</sup>	<b>(Blank)</b> Acrylic Lens <b>SG8</b> 1-piece 8FT lens for W-8	<b>UNV</b> 120-277V (Std.) <b>120</b> 120V <b>277</b> 277V <b>347</b> 347V	<b>GR</b> Generic, 0-10V 10% dim (Std.) <sup>5</sup> <b>PH</b> Philips Xitanium, 0-10V 1% dim <sup>5</sup> <b>OS</b> Osram Optotronic, 0-10V 10% dim <sup>5</sup> <b>OS1</b> Osram Optotronic, 0-10V 1% dim <sup>5</sup> <b>SD40</b> 40% / 100% Bi-Level Step dim (PH only) <b>SDXX</b> XX% / 100% Bi-Level Step dim (Specify XX : 10% ~ 70%) (PH only) <b>TD30/70</b> 30% / 70% / 100% Tri-Level Step dim (PH only) <b>TDXX/YY</b> XX% / YY% / 100% Tri-Level Step dim (Specify XX, YY : 10% ~ 70%) (PH only) <b>ES566</b> eldoLED SOLOdrive Natural Dimming to dark, 0-10V, 100% ~ 0.1% dim <b>EC</b> eldoLED ECOdrive 0-10V natural dim to 1% (Hybrid HydraDrive) <b>LDE1</b> Hi-lume 1% EcoSystem LED driver with Soft-on, Fade-to-Black dimming technology, 100% ~ 1% dim  <b>ELV</b> ELV compatible (reverse-phase or trailing-edge), (120V only) <b>PHSR</b> Philips Xitanium Sensor-Ready, Dali 5%~100% dim <b>PHDL</b> Philips Xitanium DALI driver, Dim to 5% <b>TDM</b> Triac Dim. (120V only) <b>ED560</b> eldoLED LightShape DALI dim to dark, 0.1% ~ 100% <b>LTEA2W</b> Hi-lume 1% 2-wire LED driver (120V forward phase only)   <b>BLT</b> Bluetooth Mesh System (contact factory for more information)

MOUNTING	OPTIONS	LIGHTING CONTROL SYSTEM
<b>(Blank)</b> Ceiling Mount <b>ACxx</b> Adjustable Aircraft Cable w/ Canopy (* xx = Specify length (48 or 96)) <b>YCxx</b> Adjustable Aircraft Y-cable with Toggles (* xx = Specify length in inches (60, 120, 180)) <b>SH-1/2-xx</b> 1/2" IPS STEM w/ Canopy (* xx = 18, 24, 36, 48 inches) <b>SH-3/8-xx</b> 3/8" IPS STEM w/ Canopy (* xx = 18, 24, 36, 48 inches)	<b>EMG8</b> 1296 LUMEN EM Battery Backup (CEC Compliant EM) <sup>2</sup> <b>EMG15</b> 2430 LUMEN EM Battery Backup (CEC Compliant EM) <sup>2</sup> <b>EMG20</b> 3240 LUMEN EM Battery Backup (CEC Compliant EM) <sup>2</sup> <b>EMG26</b> 4050 LUMEN EM Battery Backup (CEC Compliant EM) <sup>2</sup> <b>ELCU-200</b> Fail-to-on Emergency lighting, UL924 <sup>9</sup> <b>GTD</b> Bodine Generator Transfer Device <b>GTD10DIM</b> Bodine Generator Transfer Device (0-10VDC Dimmer Override) <b>ARRA</b> Assembled in USA for Buy American Act <b>O7W</b> Optional 7 Years Limited Warranty <sup>4</sup> <b>O10W</b> Optional 10 Years Limited Warranty <sup>4</sup> <b>LOD-500S</b> Fixture external mounted Bi-level 0-10V occupancy sensor with standard cone shape 8-15ft mounting height with coverage of 2X height, with DIP switch setting <sup>10</sup>  <b>RS-LRD</b> Remote programmer for LRD-509S and LRS-50 9S <b>LRD-509S-x</b> Fixture external mount 0-10V SmartDIM or multi-level high/low dim control occupancy sensor (*IR remote programmable), (See note 13 to select lens for "x") <sup>10, 12</sup>  <b>AMB</b> Anti-Microbial Coating (Matte Skye White) <b>HC403</b> Microwave bi-level Occupancy Sensor, adjustable via DIP switch <sup>14</sup>	<b>LUTRON VIVE</b>  <a href="#">Click Here!</a>  <b>PPA102S</b> <a href="#">Bluetooth</a> Bluetooth Powerpack (Consult factory for installation location)

NOTES:

- W- : wide housing. (not available in 8FT length)
- Contact factory for other emergency ballast options. Must specify voltage, not available with 347V.
- DesignLights Consortium® (DLC) qualified product. Not all versions of this product may be DLC qualified. Please check the DLC Qualified Products List at [www.designlights.org/QPL](http://www.designlights.org/QPL) to confirm which versions are qualified.
- This limited warranty covers electrical parts only and does not apply to labor, equipment lease, or defect from improper installation or operation. (EM battery backup does not included)
- To find an approved dimmer switch, please see table 1.
- Not available with GR driver.
- Available with C9 only.
- Lumen per watt is around 15% less than standard CRI (80+).
- Shipped separately.
- Its default setting can be found on the IR-TEC installation instructions.
- Two 4ft lenses come as standard. Must choose the SG8 option for one 8ft lens.
- Order "RS-LRD" to adjust sensor setting.
- A:** Standard cone shape Lens @ 15' height (up to 30' coverage)  
**B:** Extra wide cone shape Lens @ 10' height (up to 60' coverage)  
**C:** High bay cone shape Lens @ 30' height (up to 90' coverage)  
**D:** Standard round shape Lens @ 20' height (up to 40' coverage)  
**F:** Extra wide dome shape Lens @ 20' height (up to 80' coverage)  
**G:** Aisle way arch shape Lens @ 40' height (up to 120' coverage)
- See Table2 to find factory setting.

COMPATIBLE DIMMER SWITCH (TABLE 1)

Model #	Brand	Compatible Dimmer Switch	
(Blank)	-	<Leviton>	IllumaTech IP7 series
		<Lutron>	Visit <a href="http://www.lutron.com/advance">www.lutron.com/advance</a> for a list of dimmers (Mark VII) that will work with this driver.
		<Philips>	Sunrise : SR1200ZTUNV
ES566	eldoLED SOLOdrive	<Busch-Jaeger>	2112U-101
		<Jung>	240-10
		<Leviton>	IllumaTech - IP710-DLX
		<Lightoller Controls>	ZP600FAM120
		<Merten>	5729
		<Pass & Seymour>	CD4FB-W
		<Wattstopper>	DCLV1
		<Sensor Switch>	niO EZ
		<Synergy>	ISD BC
		<ABB>	SD/S 2.16.1
		<Lutron>	Nova T: NTFTV Diva - DVTV-xx, NFTV GRAFIK Eye: GRX-TVI w GRX3503 Energy Savr Node: QSN-4T16-S TVM2 Module
		<Crestron>	GLX-DIMFLV8, GLXP-DIMFLV8, GLPAC-DIMFLV4-*, GLPAC-DIMFLV8-*, GLPP-DIMFLVEX-PM, GLPP-1DIMFLV2EX-PM, GLPP-1DIMFLV3EX-PM, DIN-A08, DIN-4DIMFLV4, CLS-EXP-DIMFLV, CLCI-1DIMFLV2EX
LDE1	Lutron 5-Series EcoSystem	<Lutron>	PowPak Dimming Modules: RMJ-ECO32-DV-B, FCJ/FCJS-ECO <sup>1,2</sup> Energi Savr Node (120V only): QSN-1ECO-S, QSN-2ECO-S GRAFIK Eye QS/Homeworks QS control unit (120V only): QSGRJ-_E(wireless) QSGR-_E Quantum Hub (120V only): QP2-_ _2C/4C/6C/8C Homeworks QS/myRoom Plus power module (120V only): LQSE-2ECO-D
LTEA2W	Lutron Hi-lume 2-wire (120V forward voltage only)	<Lutron>	Visit <a href="http://www.lutron.com/TechnicalDocumentLibrary/369543_ENG.pdf">http://www.lutron.com/TechnicalDocumentLibrary/369543_ENG.pdf</a> for a list of compatible dimmer switches.
TDM	KEYSTONE	<Lutron>	Diva DV-600P, SkyLark S-600P, Ariadni AY-600P, Ariadni TG-603P, Maestro MA-600 (Digital), Diva CFL/LED DVCL-153P, Satin Colors DVSC-600P-SW
		<Leviton>	6641, IllumaTech IPI06-1LX, ToggleTouch TGI06-1LW (Digital)
ELV	KEYSTONE	<Lutron>	MAELV-600BL (Digital), DVELV-300P, SkyLark SELV-300P

## NOTES:

- All devices connected to one FCJ/FCJS-ECO will be controlled together. Devices will dim to the same level as the result of a control command. For more detail on adjusting low-end light level refer to Application Note#556 at [www.lutron.com](http://www.lutron.com).
- For the Line/Hot (L/H) terminal on the driver, it is preferred not to use the switched hot (red) wire from the control but rather the hot wire directly from the power source.

HC403 FACTORY SETTING (TABLE 2)

Detection Area	100%
Hold-time	5 sec
Daylight sensor	Disable
Stand-by period (tri-level control)	10 sec
Stand-by dimming level	10%

\* See a separate attachment to find more setting options.

## 2FT

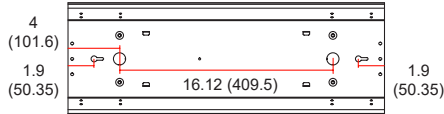

## 4FT

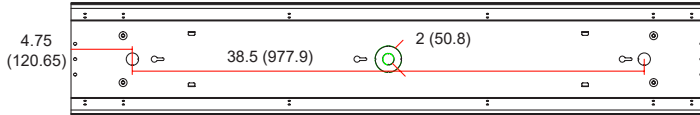

## 8FT

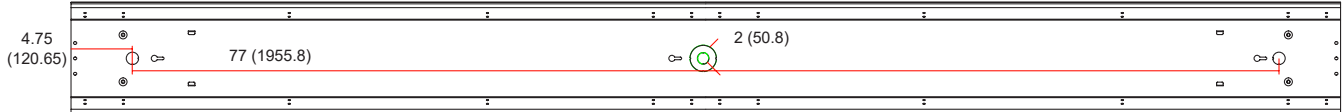

**LED lighting facts**  
A Program of the U.S. DOE

Light Output (Lumens)	9001
Watts	76.93
Lumens per Watt (Efficacy)	117

**Color Accuracy**  
Color Rendering Index (CRI) 80

**Light Color**  
Correlated Color Temperature (CCT) 3154 (Bright White)

Warm White    Bright White    Daylight  
2700K    3000K    4500K    6500K

All results are according to IESNA LM-79-2008. Approved Method for the Electrical and Photometric Testing of Solid-State Lighting. The U.S. Department of Energy (DOE) verifies product test data and results.

Visit [www.lightingfacts.com](http://www.lightingfacts.com) for the Label Reference Guide.

Registration Number: ZN60-PKCAIT (7/28/2017)  
Model Number: 98-72LED030-UNV  
Type: Luminaire - Under

**LED lighting facts**  
A Program of the U.S. DOE

Light Output (Lumens)	12860
Watts	109.8
Lumens per Watt (Efficacy)	117.12

**Color Accuracy**  
Color Rendering Index (CRI) 80

**Light Color**  
Correlated Color Temperature (CCT) 3170 (Bright White)

Warm White    Bright White    Daylight  
2700K    3000K    4500K    6500K

**Warranty\*\*** Yes

All results, except LED Lumen Maintenance, are according to IESNA LM-79-2008. Approved Method for the Electrical and Photometric Testing of Solid-State Lighting. The U.S. Department of Energy (DOE) verifies product test data and results.

\*\* See [www.lightingfacts.com/products](http://www.lightingfacts.com/products) for details.

Registration Number: ZN60-806XTA (7/28/2017)  
Model Number: 98-138LED030-UNV  
Type: Luminaire - Under

**LED lighting facts**  
A Program of the U.S. DOE

Light Output (Lumens)	6333
Watts	58
Lumens per Watt (Efficacy)	109.19

**Color Accuracy**  
Color Rendering Index (CRI) 80

**Light Color**  
Correlated Color Temperature (CCT) 3171 (Bright White)

Warm White    Bright White    Daylight  
2700K    3000K    4500K    6500K

**Warranty\*\*** Yes

All results, except LED Lumen Maintenance, are according to IESNA LM-79-2008. Approved Method for the Electrical and Photometric Testing of Solid-State Lighting. The U.S. Department of Energy (DOE) verifies product test data and results.

\*\* See [www.lightingfacts.com/products](http://www.lightingfacts.com/products) for details.

Registration Number: ZN60-CKMKQW (7/28/2017)  
Model Number: 94-54LED030-UNV  
Type: Luminaire - Under

**LED lighting facts**  
A Program of the U.S. DOE

Light Output (Lumens)	2741
Watts	24.85
Lumens per Watt (Efficacy)	110.3

**Color Accuracy**  
Color Rendering Index (CRI) 79

**Light Color**  
Correlated Color Temperature (CCT) 3082 (Bright White)

Warm White    Bright White    Daylight  
2700K    3000K    4500K    6500K

**Warranty\*\*** Yes

All results, except LED Lumen Maintenance, are according to IESNA LM-79-2008. Approved Method for the Electrical and Photometric Testing of Solid-State Lighting. The U.S. Department of Energy (DOE) verifies product test data and results.

\*\* See [www.lightingfacts.com/products](http://www.lightingfacts.com/products) for details.

Registration Number: ZN60-Q8Y4VX (7/28/2017)  
Model Number: 92-25LED030-UNV  
Type: Luminaire - Under

**LED lighting facts**  
A Program of the U.S. DOE

Light Output (Lumens)	2195
Watts	19.42
Lumens per Watt (Efficacy)	113.03

**Color Accuracy**  
Color Rendering Index (CRI) 84

**Light Color**  
Correlated Color Temperature (CCT) 5291 (Daylight)

Warm White    Bright White    Daylight  
2700K    3000K    4500K    6500K

**Warranty\*\*** Yes

All results, except LED Lumen Maintenance, are according to IESNA LM-79-2008. Approved Method for the Electrical and Photometric Testing of Solid-State Lighting. The U.S. Department of Energy (DOE) verifies product test data and results.

\*\* See [www.lightingfacts.com/products](http://www.lightingfacts.com/products) for details.

Registration Number: ZN60-Q5LQ4 (7/17/2017)  
Model Number: 92-18LED030-UNV  
Type: Luminaire - Under

**LED lighting facts**  
A Program of the U.S. DOE

Light Output (Lumens)	2203
Watts	19.38
Lumens per Watt (Efficacy)	113.67

**Color Accuracy**  
Color Rendering Index (CRI) 80

**Light Color**  
Correlated Color Temperature (CCT) 3094 (Bright White)

Warm White    Bright White    Daylight  
2700K    3000K    4500K    6500K

All results are according to IESNA LM-79-2008. Approved Method for the Electrical and Photometric Testing of Solid-State Lighting. The U.S. Department of Energy (DOE) verifies product test data and results.

Visit [www.lightingfacts.com](http://www.lightingfacts.com) for the Label Reference Guide.

Registration Number: ZN60-Q2BLYB (5/9/2017)  
Model Number: 92-18LED030-UNV  
Type: Luminaire - Under

# W LED

**W-2-18LED**

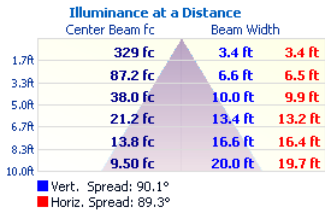

**W-2-25LED**

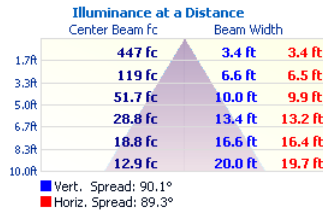

**W-2-36LED**

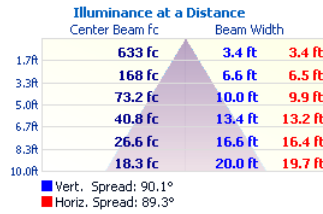

**W-4-54LED**

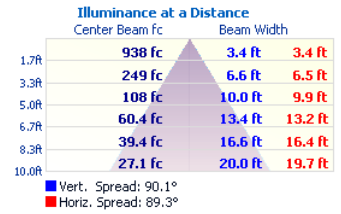

**W-4-72LED**

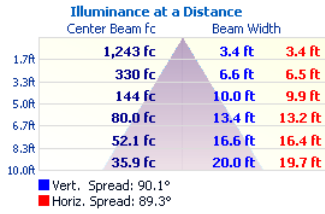

**W-8-108LED**

